



拉菲豪爵<sup>木</sup>  
LAFEI HAOJUE

HIGH-END  
COLOR CARD

高端烤漆色卡  
2025 版



拉菲豪爵<sup>木</sup>  
LAFEI HAOJUE



携手助力拉菲豪爵  
(建国大业)

温馨提示

本公司产品您可自由选择。图示仅为公司部分产品，印刷过程可能令资料的产品图片跟实物有细微区别。  
颜色与款式以实物为准，公司保留更改产品设计与规划的权利，最终解释权属本公司，详情请咨询当地经销商。

门·墙·柜 一体化

Space  
Mei  
高定时代  
空间美学



重塑理享空间  
引领门墙柜一体化时代

>

>门墙柜一体化的设计理念，追求“以少胜多”，要求将门、墙板、功能柜融为一体，以个性化的风格整合家居空间，实现室内空间价值最大化、风格一致化、功能齐全化。

>这既是对空间秩序的统一化处理，也是彰显个性的另一种表达，更加符合当下消费者个性追求、崇尚功能的需求。

洞察用户需求  
提供一体化空间美学解决方案

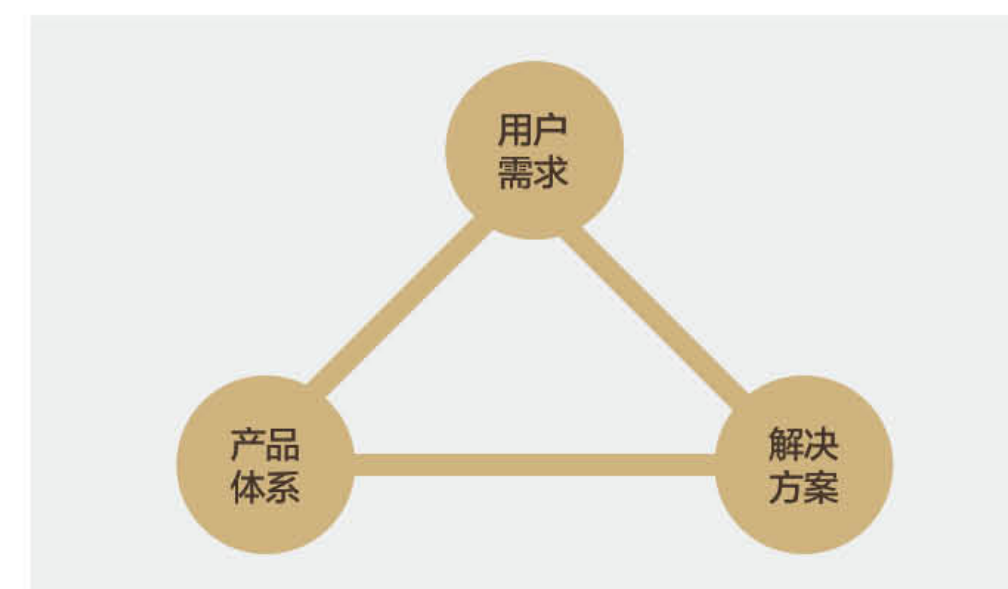



整装-01

M+ 精定制 — 时尚水线系列

DOOR AND WALL CABINET · Fashion Waterline Series

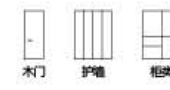

温馨提示：由于天然木材存在纹理差异，本色板仅供选择参考，请以实物为准。 P 02-03

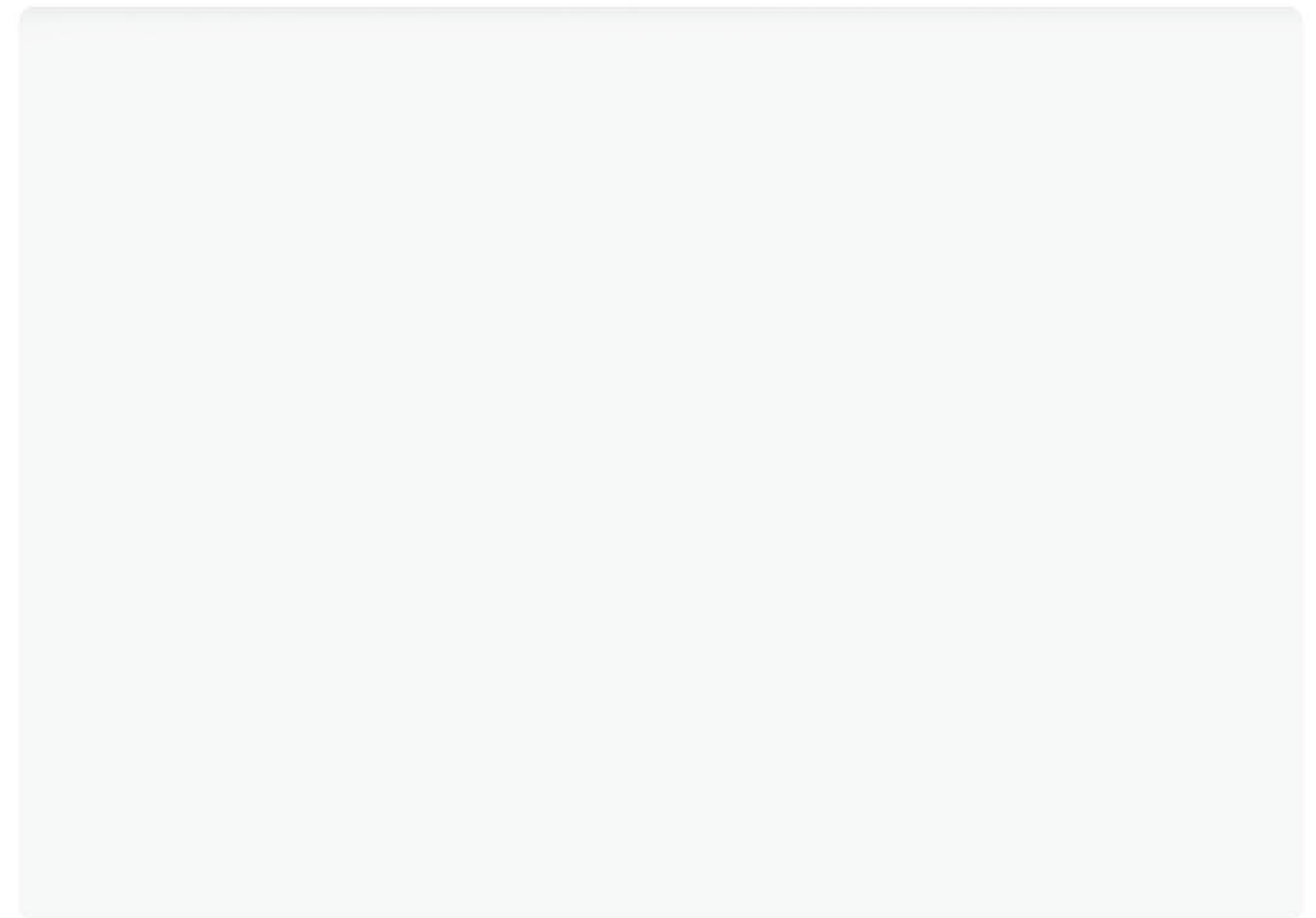

Color Name: | **HY25-01**

门墙柜一体化定制系统 Doors Walls Cabinets

720° 全景体验



25-001

25-002

25-003

25-004

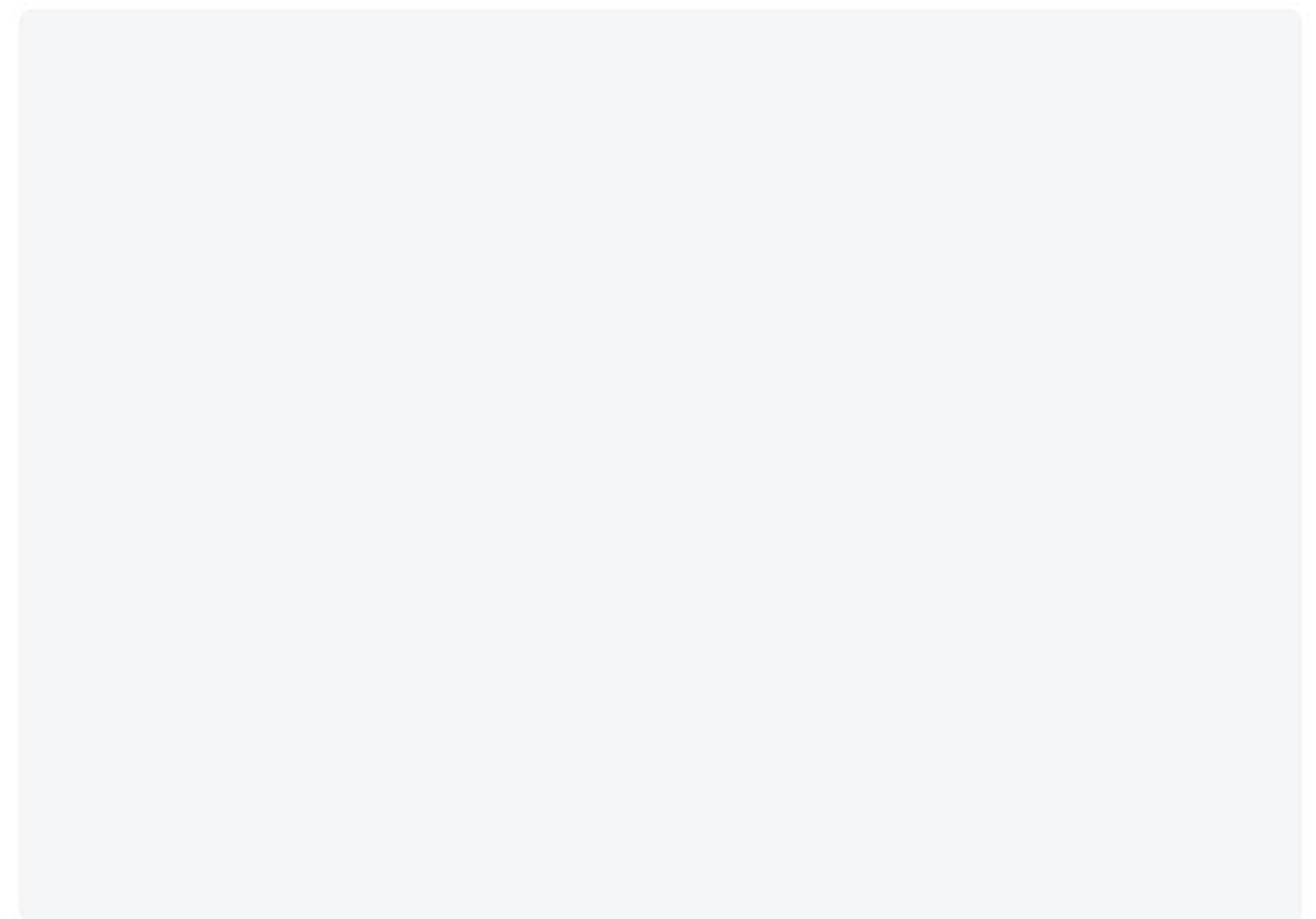

Color Name: | **HY25-02**

门墙柜一体化定制系统 Doors Walls Cabinets

720° 全景体验



P 04-05 温馨提示：由于天然木材存在纹理差异，本色板仅供选择参考，请以实物为准。

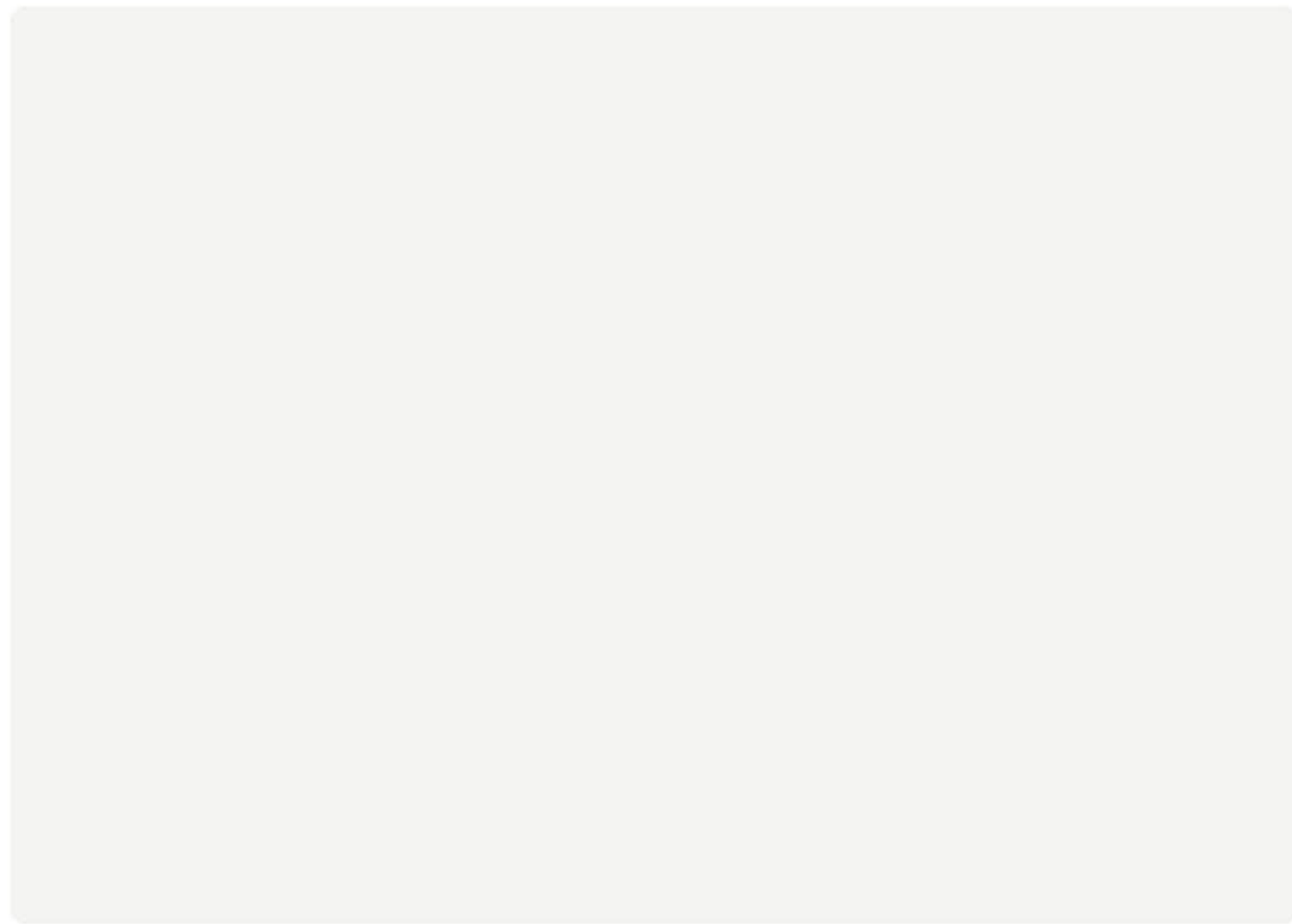
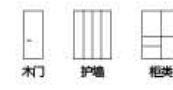

Color Name: **HY25-03**

门墙柜一体化定制系统 Doors Walls Cabinets

720° 全景体验



DOOR AND WALL CABINET · Fashion Waterline Series

25-005

M+ 精定制 —— 时尚水线系列

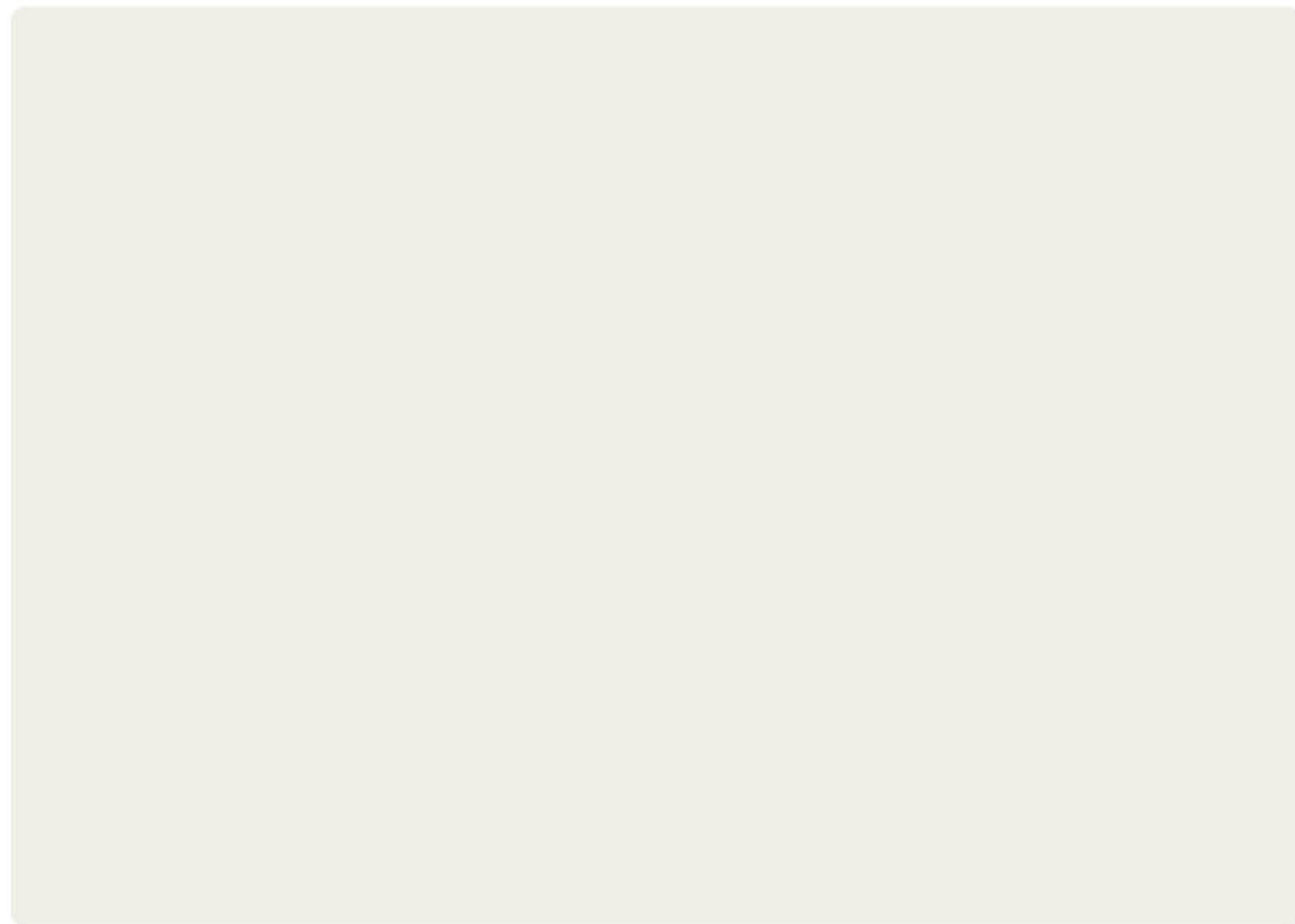

Color Name: **HY25-04**

门墙柜一体化定制系统 Doors Walls Cabinets

720° 全景体验



25-006



25-007



25-008



25-009



25-010

M+ 精定制 — 时尚法式系列

DOOR AND WALL CABINET · Fashionable French collection

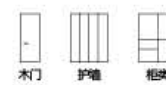

温馨提示：由于天然木材存在纹理差异，本面板仅供选择参考，请以实物为准。 P 06-07

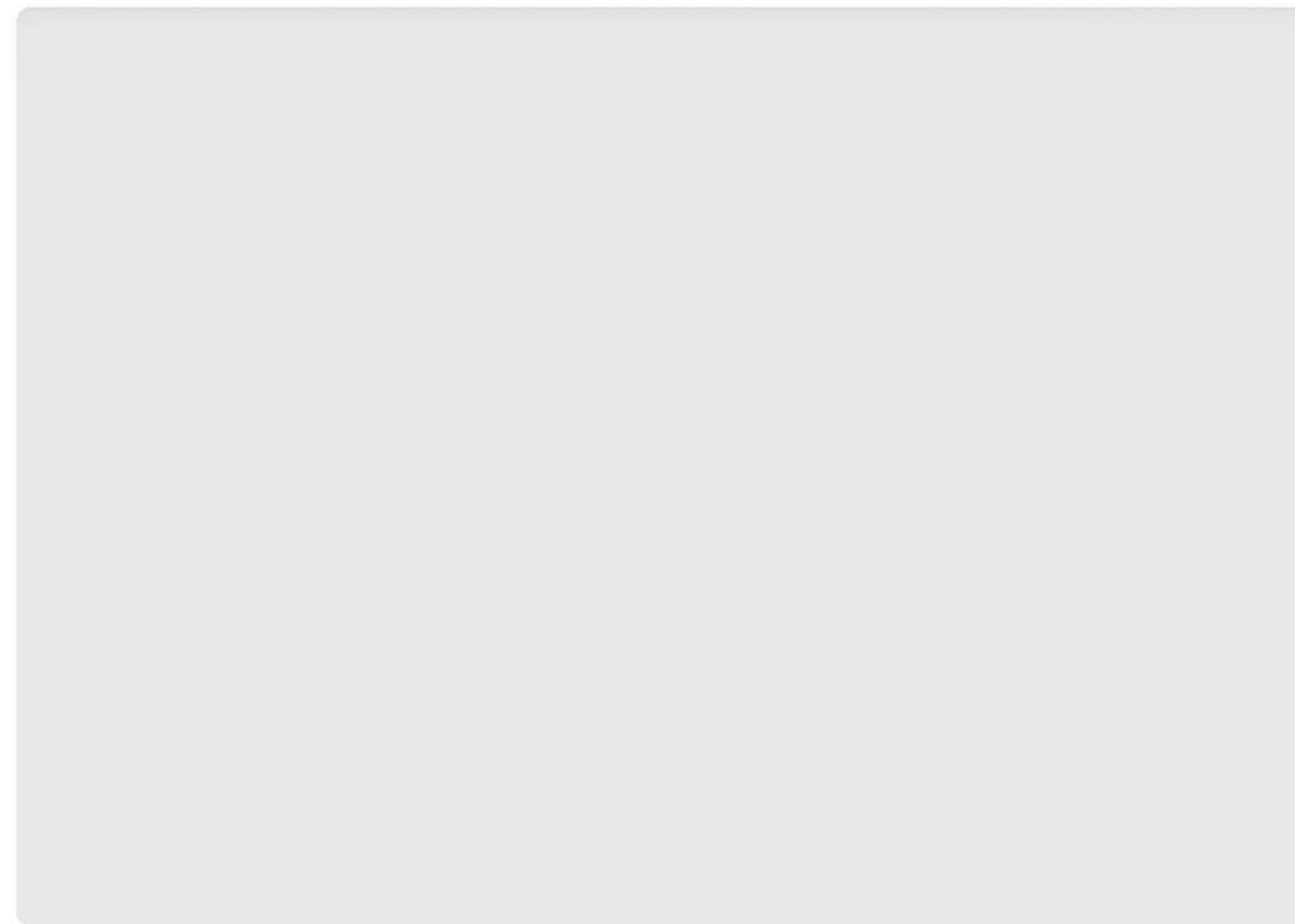

Color Name: | **HY25-05**

门墙柜一体化定制系统 Doors Walls Cabinets

720° 全景体验



25-011



25-012



25-013



25-014



Color Name: | **HY25-06**

门墙柜一体化定制系统 Doors Walls Cabinets

720° 全景体验



P 08-09 温馨提示：由于天然木材存在纹理差异，本色板仅供选择参考，请以实物为准。

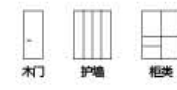

Color Name: **HY25-07**

门墙柜一体化定制系统 Doors Walls Cabinets

720° 全景体验



DOOR AND WALL CABINET · Fashion Waterline Series

M+ 精定制 —— 时尚水线系列

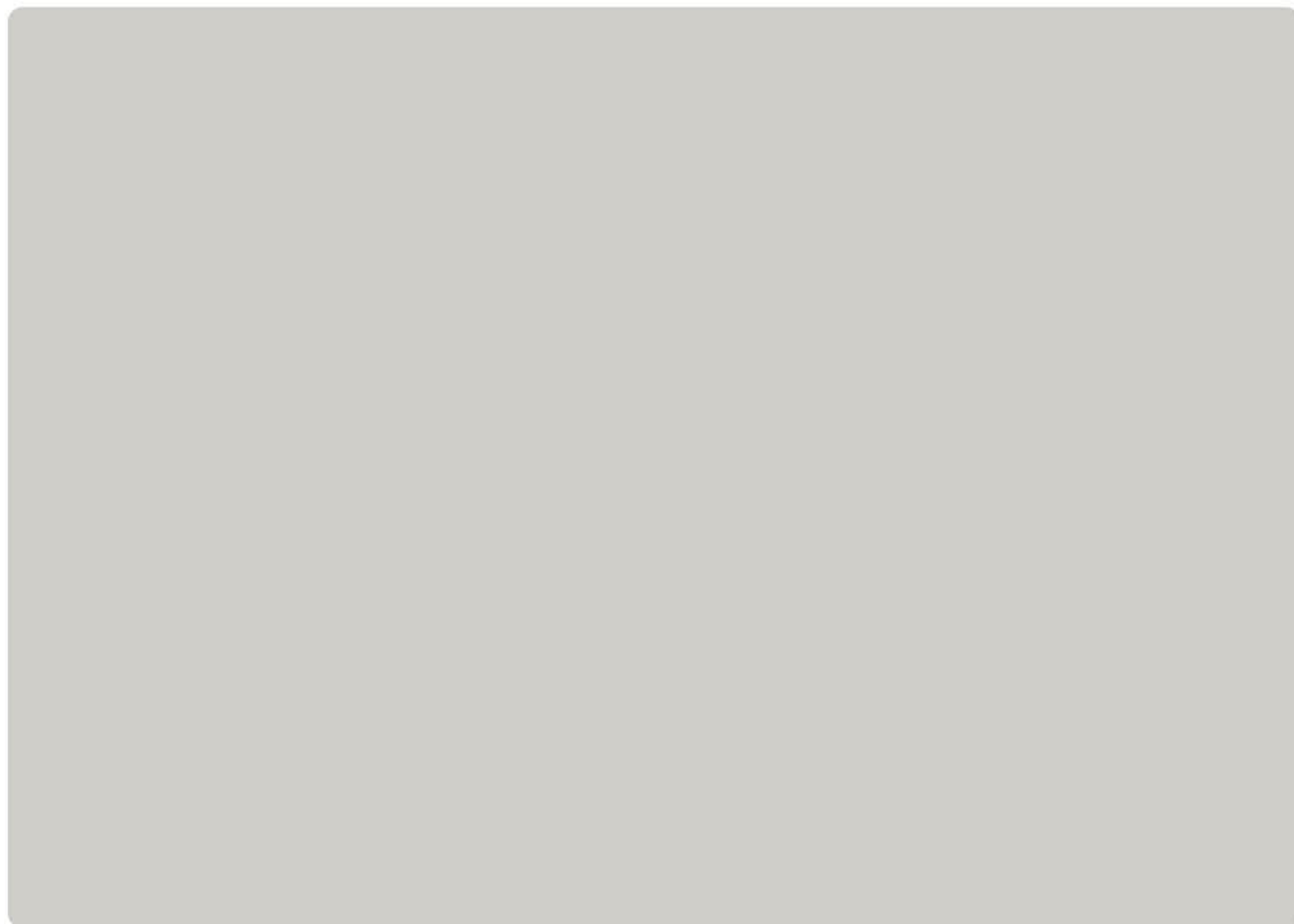

Color Name: **HY25-08**

门墙柜一体化定制系统 Doors Walls Cabinets

720° 全景体验



25-016



25-017



25-018



25-019



25-020

M+ 精定制 — 时尚扣线系列

DOOR AND WALL CABINET · Fashion buckle series

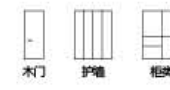

温馨提示：由于天然木材存在纹理差异，本色板仅供选择参考，请以实物为准。 P 10-11

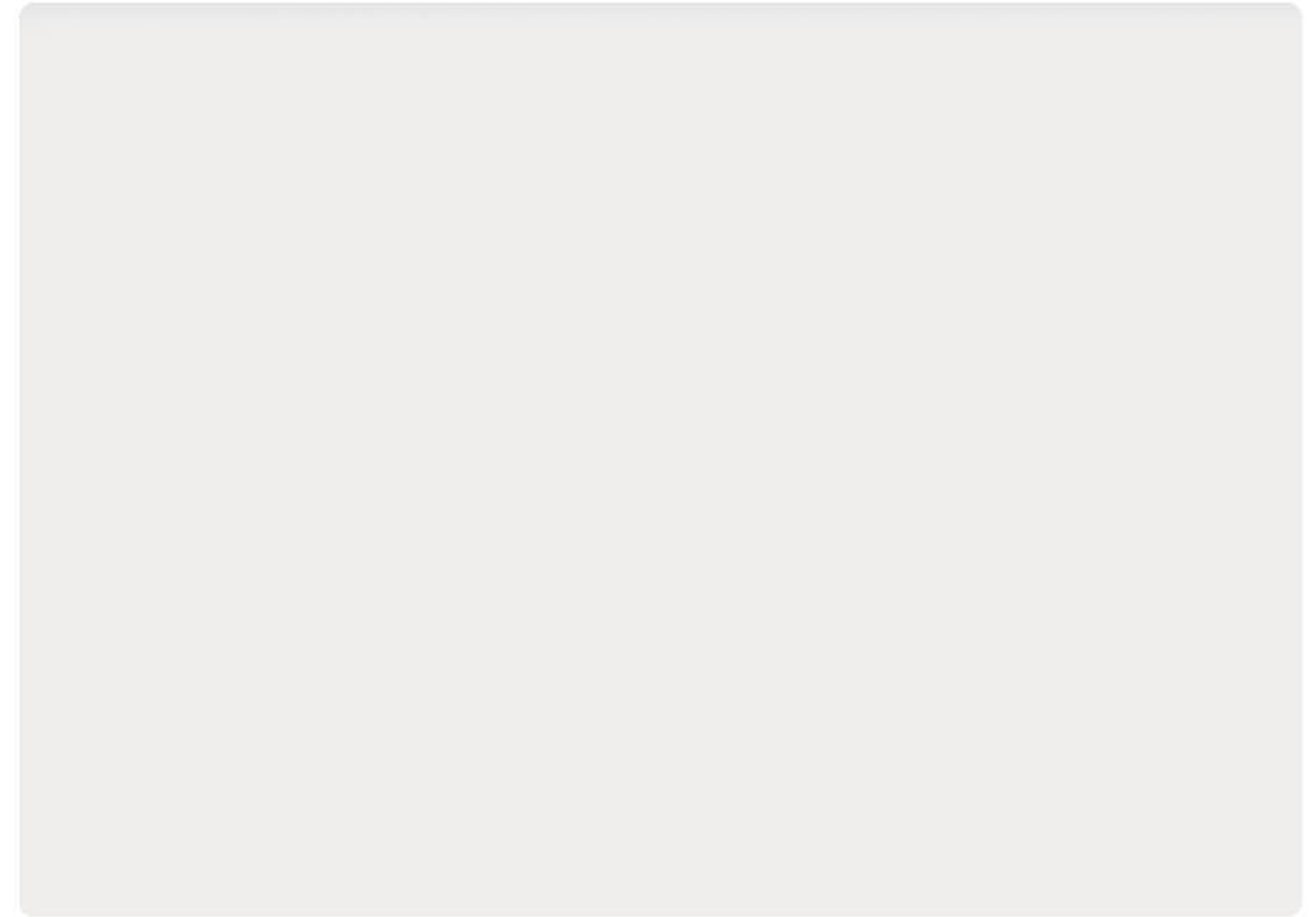

Color Name: | **HY25-09**

门墙柜一体化定制系统 Doors Walls Cabinets

720° 全景体验



25-021



25-022



25-023



25-024

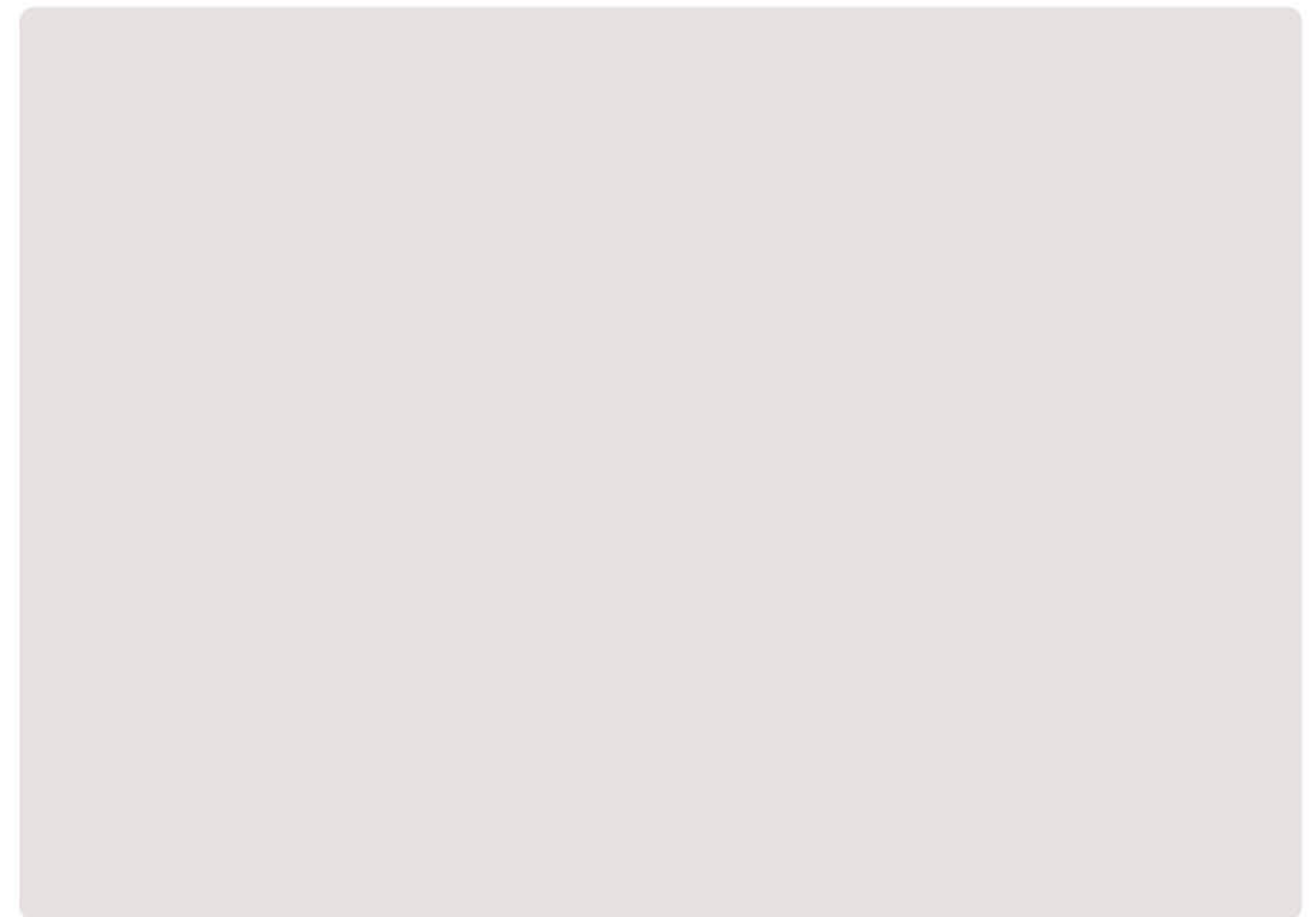

Color Name: | **HY25-10**

门墙柜一体化定制系统 Doors Walls Cabinets

720° 全景体验



P 12-13 温馨提示：由于天然木材存在纹理差异，本色板仅供选择参考，请以实物为准。

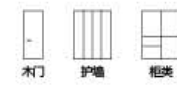

Color Name: **HY25-11**

门墙柜一体化定制系统 Doors Walls Cabinets

720° 全景体验



DOOR AND WALL CABINET · Fashion grille series

M+ 精定制 — 时尚格栅系列



Color Name: **HY25-12**

门墙柜一体化定制系统 Doors Walls Cabinets

720° 全景体验



25-026



25-027



25-028



25-029

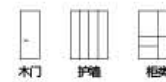

温馨提示：由于天然木材存在纹理差异，本色板仅供选择参考，请以实物为准。 P 14-15



25-030

M+ 精定制 — 时尚水线系列

DOOR AND WALL CABINET · Fashion Waterline Series

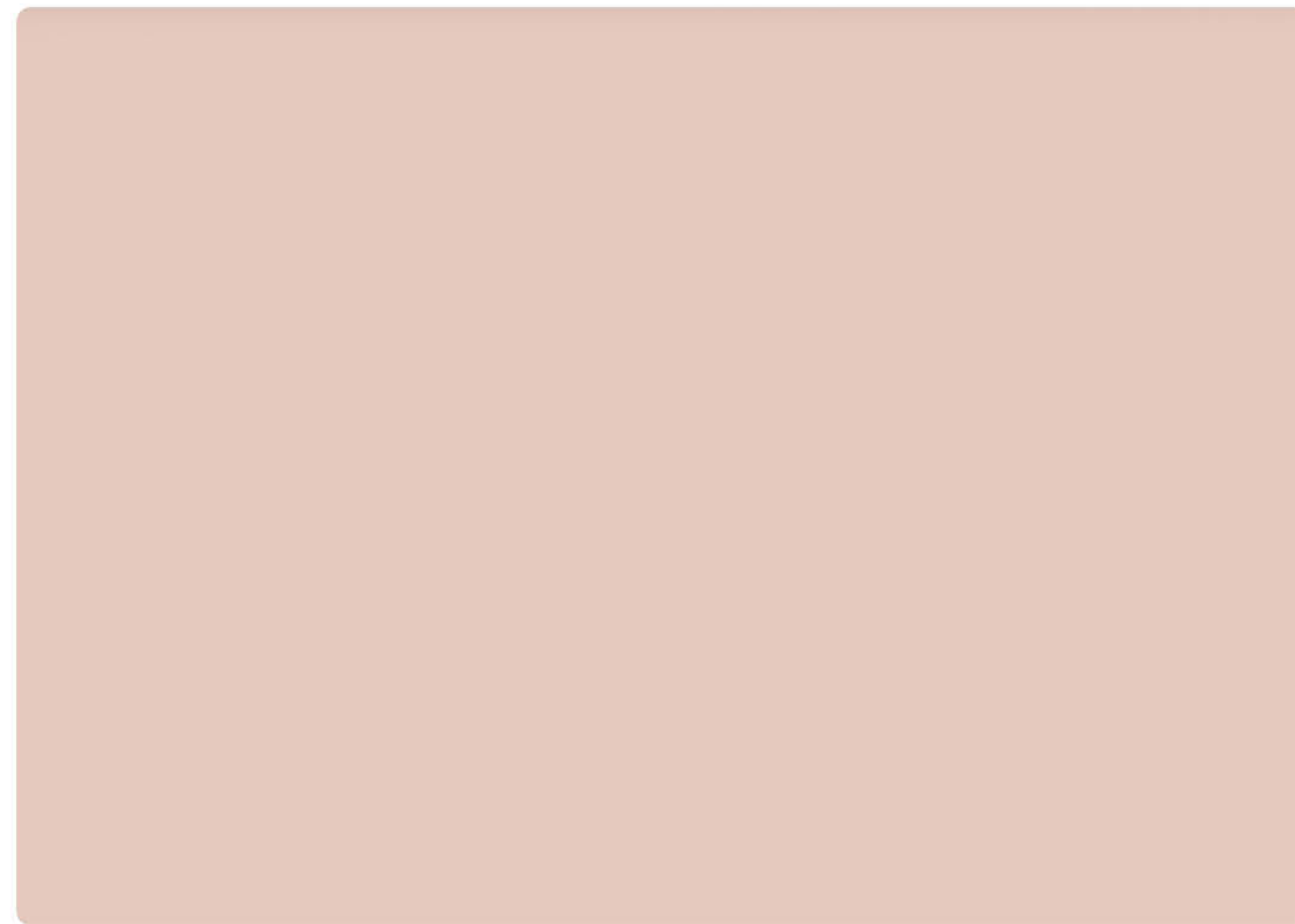

Color Name: | **HY25-13**

门墙柜一体化定制系统 Doors Walls Cabinets

720° 全景体验



25-031

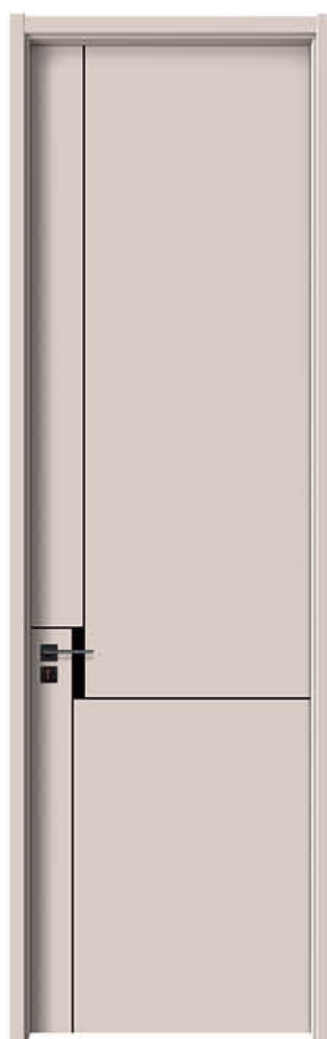

25-032

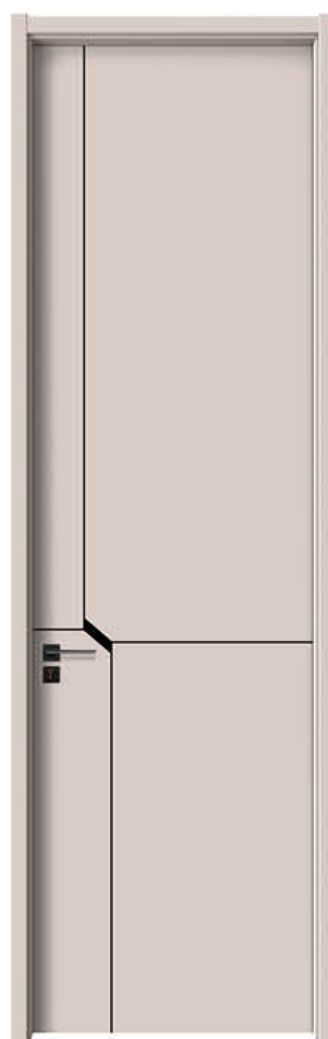

25-033



25-034

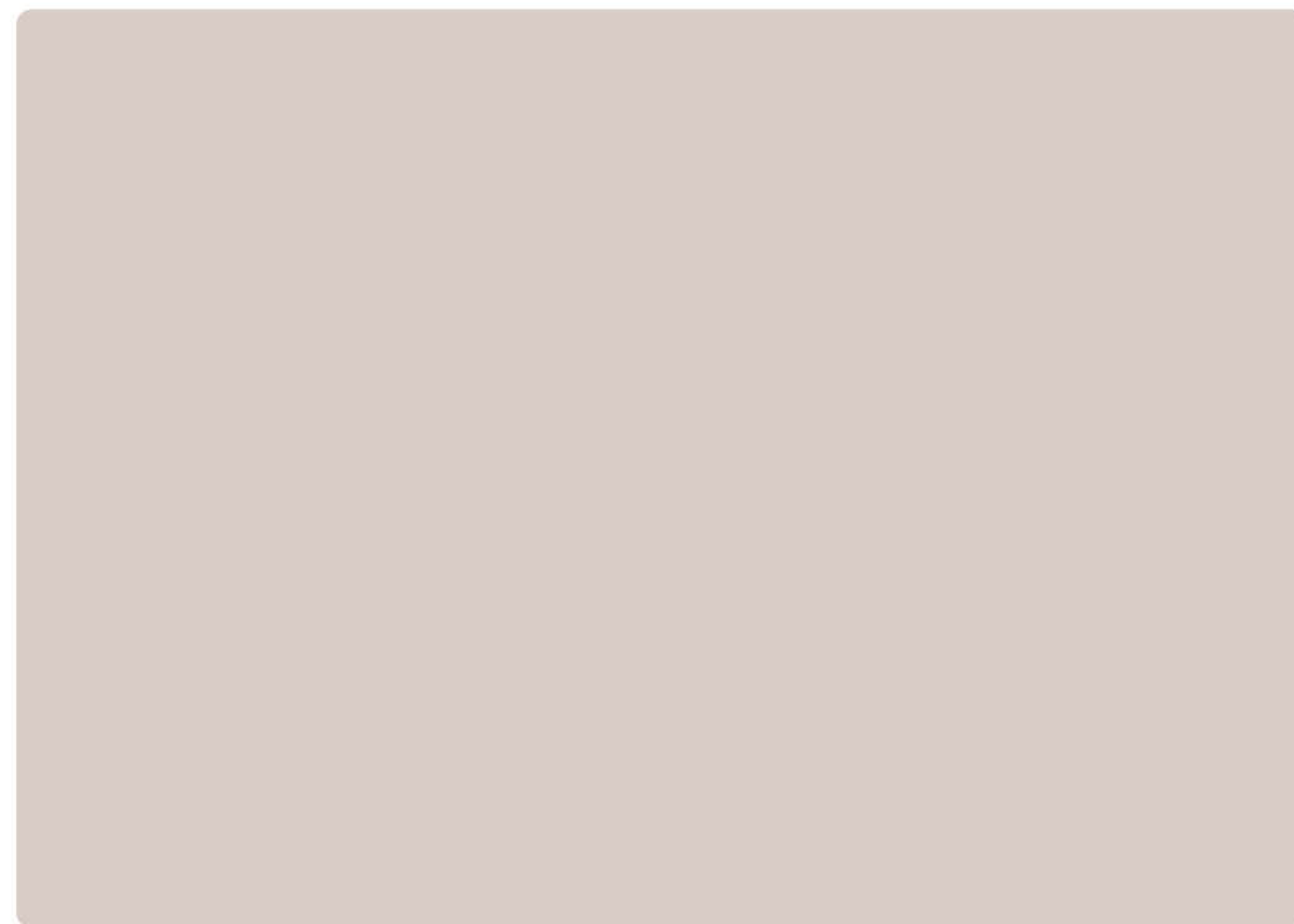

Color Name: | **HY25-14**

门墙柜一体化定制系统 Doors Walls Cabinets

720° 全景体验



P 16-17 温馨提示：由于天然木材存在纹理差异，本色板仅供选择参考，请以实物为准。

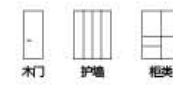

Color Name: | **HY25-15**

门墙柜一体化定制系统 Doors Walls Cabinets

720° 全景体验



Color Name: | **HY25-16**

门墙柜一体化定制系统 Doors Walls Cabinets

720° 全景体验



25-035

DOOR AND WALL CABINET · Fashionable French collection

M+ 精定制 —— 时尚法式系列



QUALITY  
UNIQUE SCENERY

不同的视角，呈现不同的交织。  
坚硬的线条包裹着温柔的力量。  
让空间更加灵动洒脱。  
为家居生活带来别样的开合体验。



25-036



25-037



25-038



25-039

M+ 精定制 — 幼儿园医院系列

DOOR AND WALL CABINET · Kindergarten Hospital Series

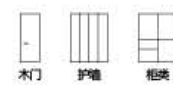

温馨提示：由于天然木材存在纹理差异，本色板仅供选择参考，请以实物为准。 P 18-19

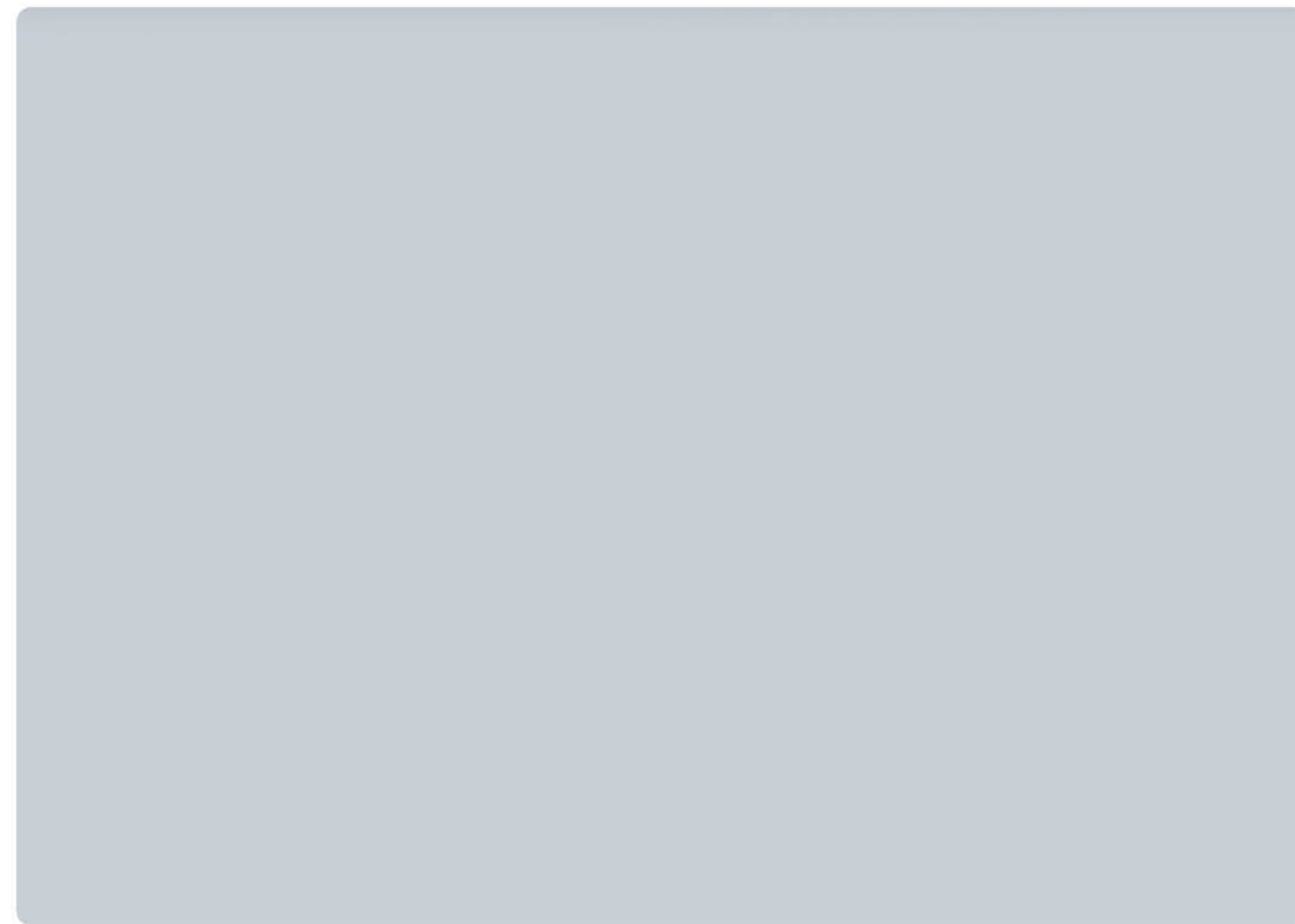

Color Name: | **HY25-17**

门墙柜一体化定制系统 Doors Walls Cabinets

720° 全景体验



25-040



25-041



25-042



25-043

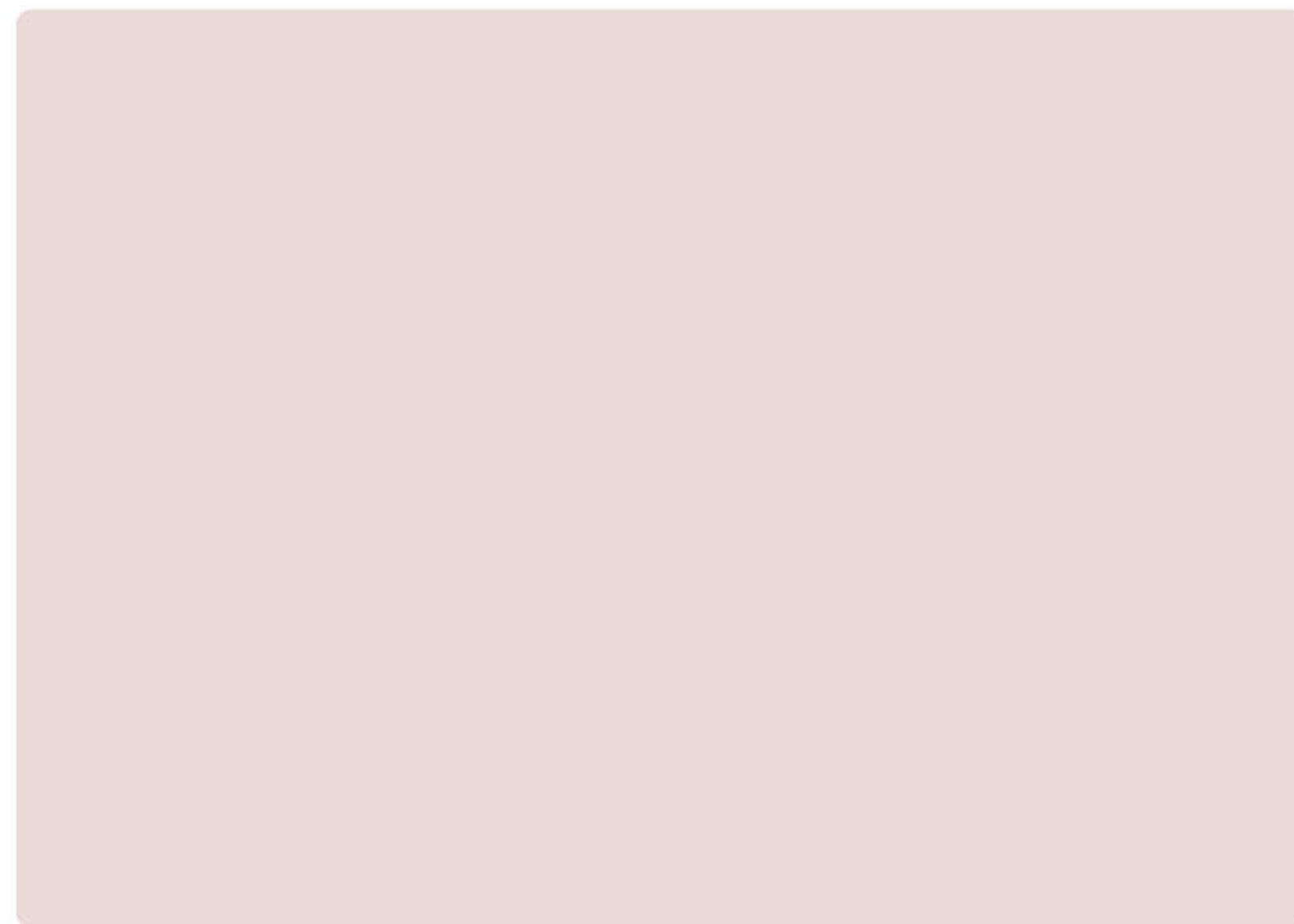

Color Name: | **HY25-18**

门墙柜一体化定制系统 Doors Walls Cabinets

720° 全景体验



P 20-21 温馨提示：由于天然木材存在纹理差异，本色板仅供选择参考，请以实物为准。

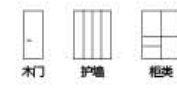

Color Name: **HY25-19**

门墙柜一体化定制系统 Doors Walls Cabinets

720° 全景体验



25-044

DOOR AND WALL CABINET · Fashionable French collection

M\* 精定制 —— 时尚法式系列



Color Name: **HY25-20**

门墙柜一体化定制系统 Doors Walls Cabinets

720° 全景体验



25-045



25-046



25-047



25-048



整装-02

M+ 精定制 — 时尚扣线系列

DOOR AND WALL CABINET · Fashion buckle series

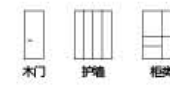

温馨提示：由于天然木材存在纹理差异，本色板仅供选择参考，请以实物为准。 P 22-23

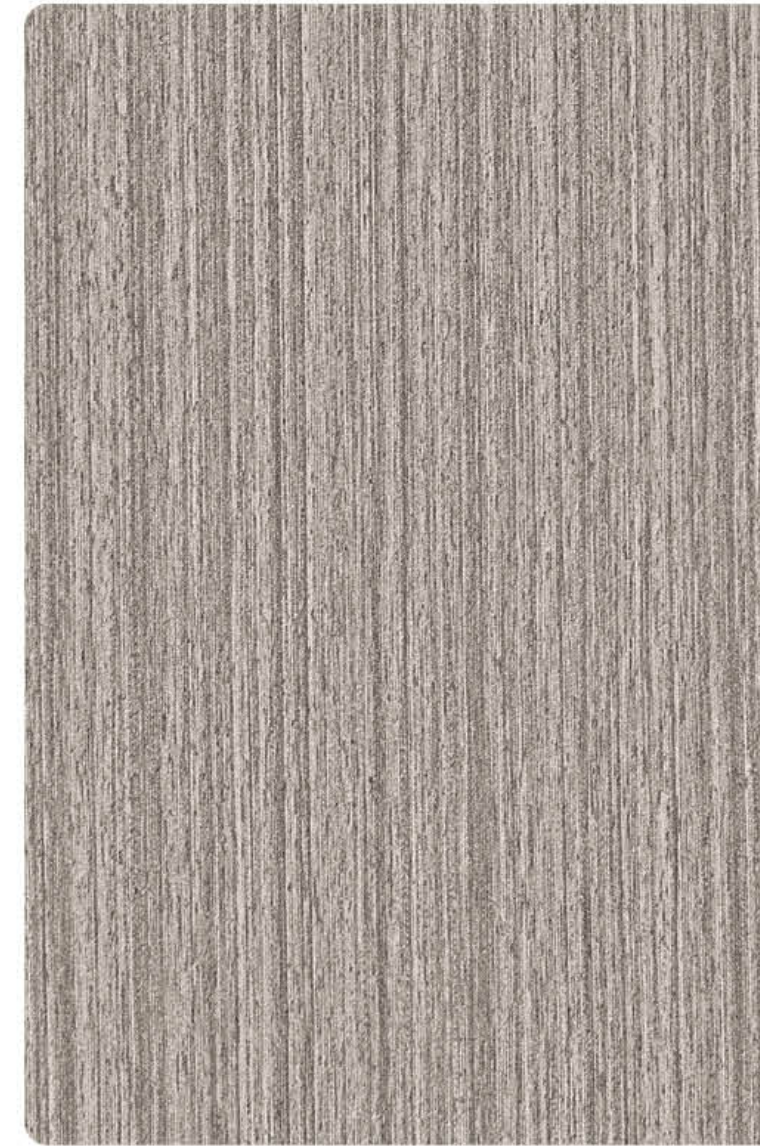

Color Name: TZZ25-21

门墙柜一体化定制系统 Doors Walls Cabinets

720° 全景体验



Color Name: TZZ25-22

门墙柜一体化定制系统 Doors Walls Cabinets

720° 全景体验



25-049



25-050



25-051



25-052



Color Name: TZZ25-23

门墙柜一体化定制系统 Doors Walls Cabinets

720° 全景体验



Color Name: TZZ25-24

门墙柜一体化定制系统 Doors Walls Cabinets

720° 全景体验



P 24-25 温馨提示：由于天然木材存在纹理差异，本色板仅供选择参考，请以实物为准。



Color Name: TZ25-25

颜色名称: TZ25-25

720° 全景体验



门墙柜一体化定制系统 Doors Walls Cabinets



Color Name: TZ25-26

颜色名称: TZ25-26

720° 全景体验



门墙柜一体化定制系统 Doors Walls Cabinets



Color Name: TZ25-27

颜色名称: TZ25-27

720° 全景体验



门墙柜一体化定制系统 Doors Walls Cabinets



Color Name: TZ25-28

颜色名称: TZ25-28

720° 全景体验



门墙柜一体化定制系统 Doors Walls Cabinets



25-053

DOOR AND WALL CABINET · Classic Chinese Series

M\* 精定制 —— 经典中式系列



25-054



25-055



25-056



25-057



25-058

M+ 精定制 — 经典中式系列

DOOR AND WALL CABINET · Classic Chinese Series



Color Name: KF25-29 (白橡木半透 1号)

720° 全景体验

门墙柜一体化定制系统 Doors Walls Cabinets



25-059



25-060



25-061



25-062

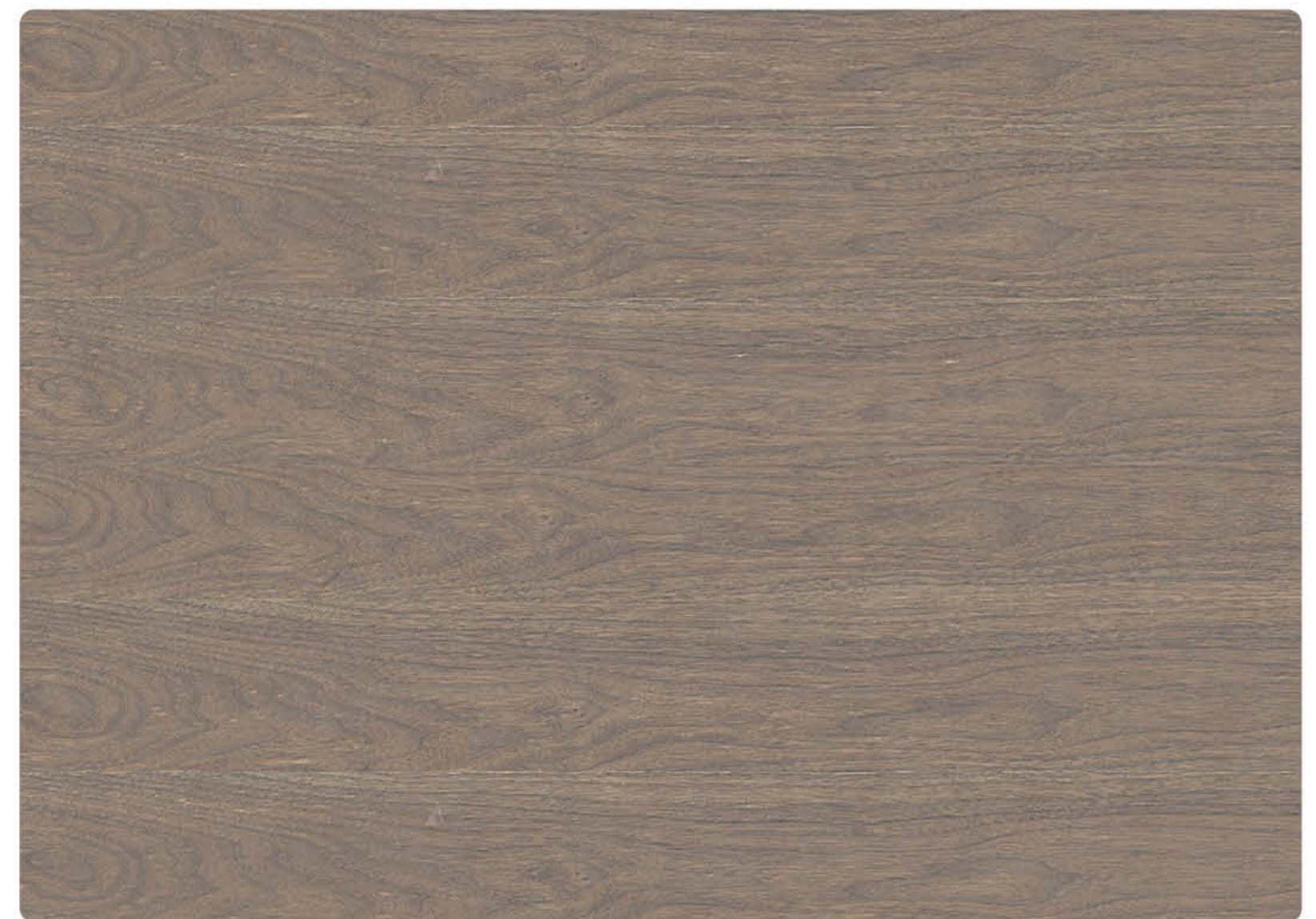

Color Name: KF25-30 (黑胡桃半透 3号)

720° 全景体验

门墙柜一体化定制系统 Doors Walls Cabinets



P 28-29 温馨提示：由于天然木材存在纹理差异，本色板仅供选择参考，请以实物为准。

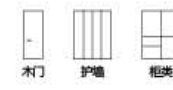

Color Name: **KF25-31** (白橡木半透2号)

720° 全景体验



门墙柜一体化定制系统 Doors Walls Cabinets

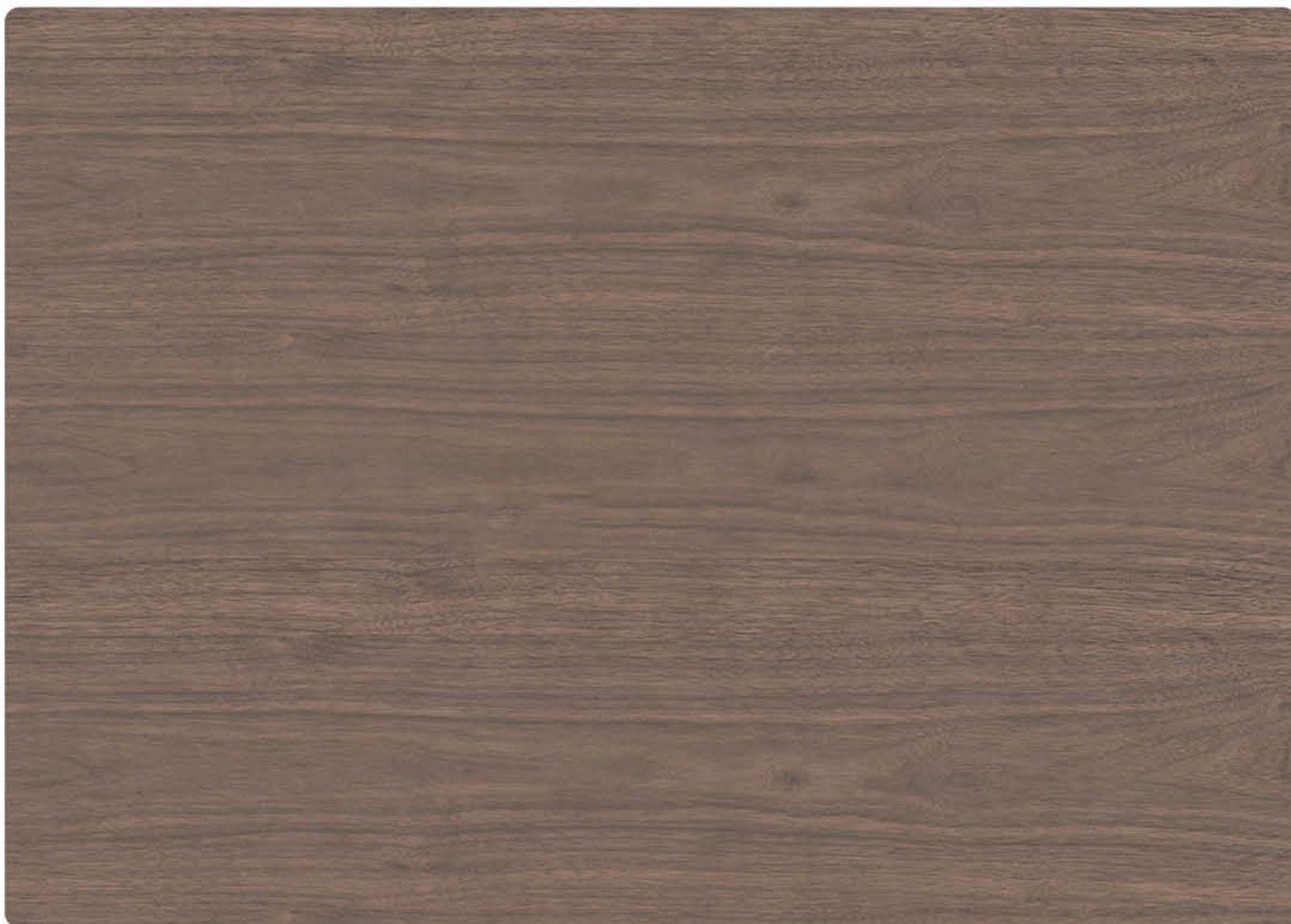

Color Name: **KF25-32** (黑胡桃半透1号)

720° 全景体验



门墙柜一体化定制系统 Doors Walls Cabinets



25-063

DOOR AND WALL CABINET · Fashion Waterline Series

M+ 精定制 时尚水线系列



25-064



25-065



25-066



25-067



25-068

M+ 精定制 — 时尚水线系列

DOOR AND WALL CABINET · Fashion Waterline Series

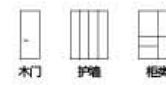

温馨提示：由于天然木材存在纹理差异，本色板仅供选择参考，请以实物为准。 P 30-31

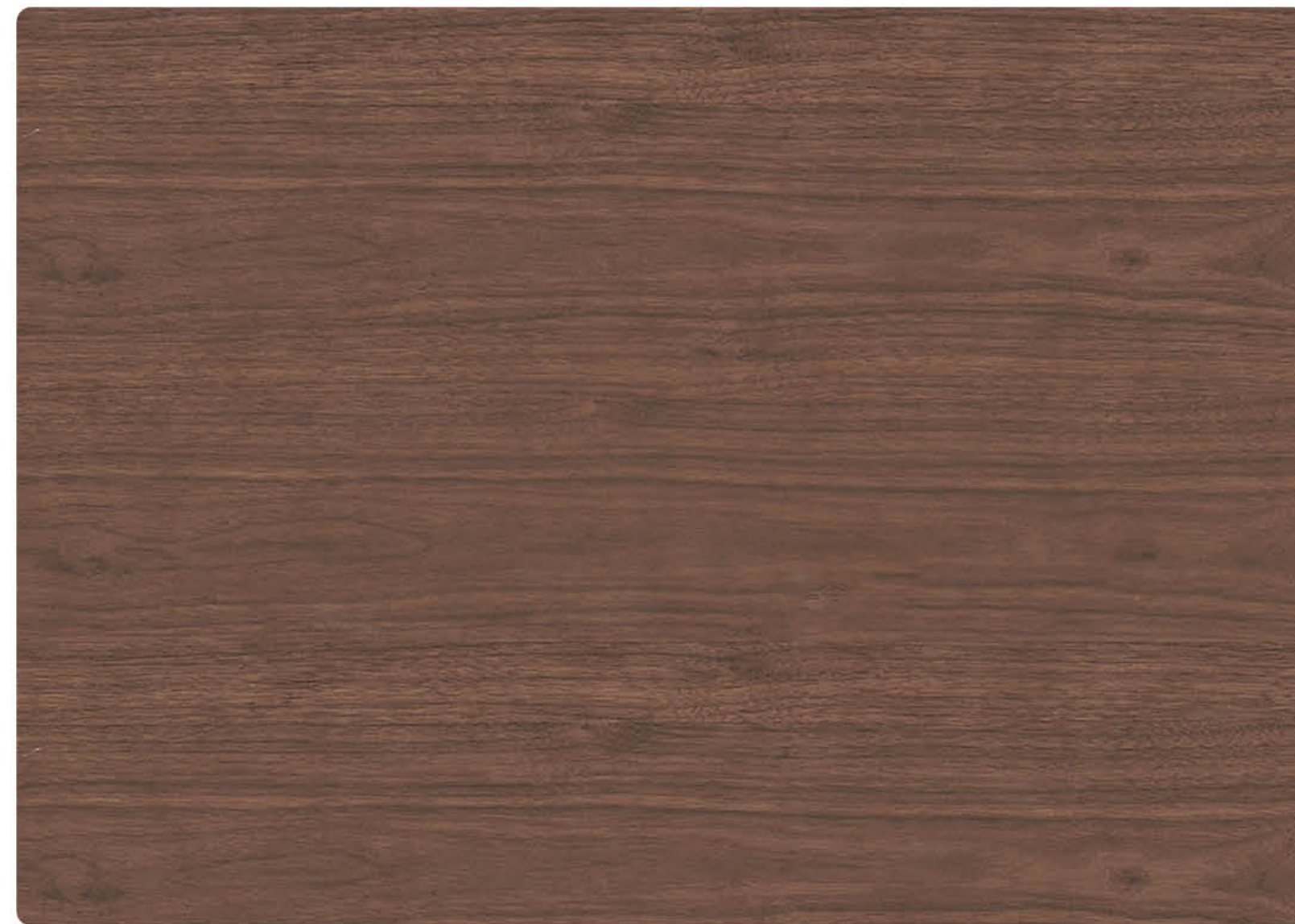

Color Name: | **KF25-33** (黑胡桃半透 2号)

720° 全景体验



门墙柜一体化定制系统 Doors Walls Cabinets



25-069



25-070



25-071



25-072



Color Name: | **KF25-34** (榆木半透 1号)

720° 全景体验



门墙柜一体化定制系统 Doors Walls Cabinets

P 32-33 温馨提示：由于天然木材存在纹理差异，本色板仅供选择参考，请以实物为准。

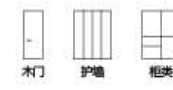

Color Name: **KF25-35** (黑胡桃半透 4号)

720° 全景体验



门墙柜一体化定制系统 Doors Walls Cabinets



25-073

DOOR AND WALL CABINET · Fashion Waterline Series

M+ 精定制 —— 时尚水线系列



Color Name: **KF25-36** (榆木半透 2号)

720° 全景体验



门墙柜一体化定制系统 Doors Walls Cabinets



25-074



25-075



25-076



25-077



25-078

DOOR AND WALL CABINET · Fashion Trench Series

M+ 精定制 — 时尚沟槽系列

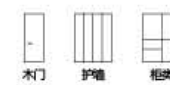

温馨提示：由于天然木材存在纹理差异，本色板仅供选择参考，请以实物为准。 P 34-35



Color Name: TB25-37 (红樱桃)

门墙柜一体化定制系统 Doors Walls Cabinets

720° 全景体验

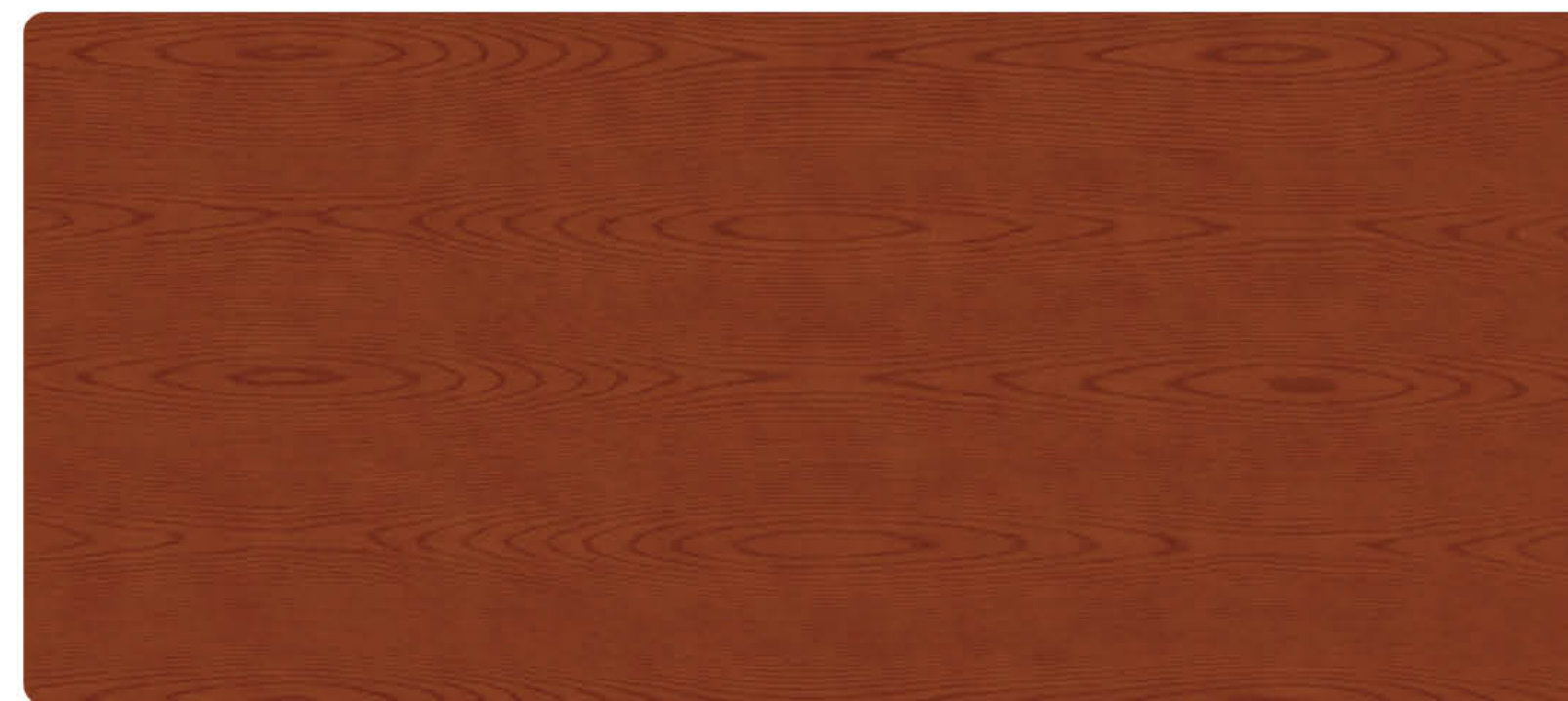

Color Name: TB25-38 (水曲柳面板)

门墙柜一体化定制系统 Doors Walls Cabinets

720° 全景体验



Color Name: TB25-39 (EV黑胡桃)

门墙柜一体化定制系统 Doors Walls Cabinets

720° 全景体验



25-079



25-080



25-081



25-082

P 36-37 温馨提示：由于天然木材存在纹理差异，本色板仅供选择参考，请以实物为准。



Color Name: **TB25-40** (山纹红玫瑰)

门墙柜一体化定制系统 Doors Walls Cabinets

720° 全景体验



Color Name: **TB25-41** (卡斯楠)

门墙柜一体化定制系统 Doors Walls Cabinets

720° 全景体验

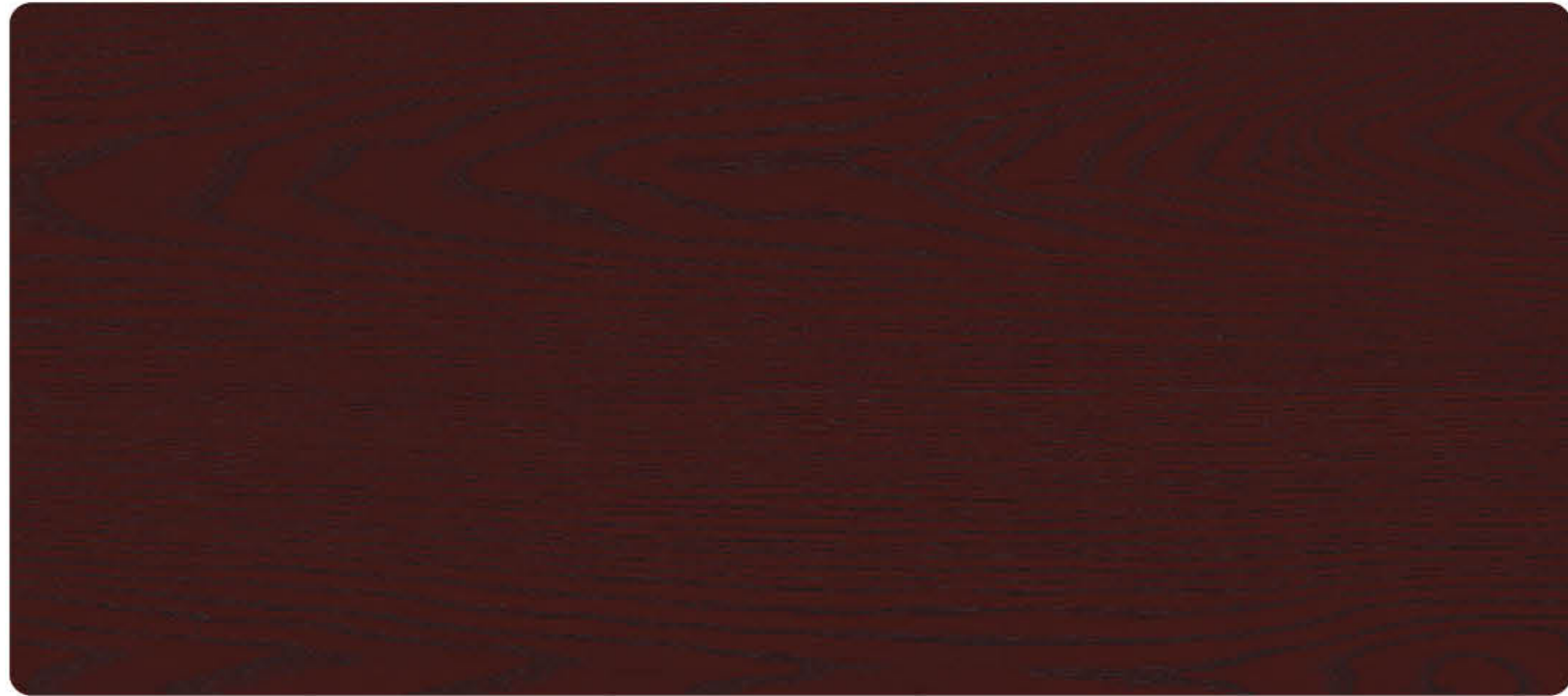

Color Name: **TB25-42** (红橡面板)

门墙柜一体化定制系统 Doors Walls Cabinets

720° 全景体验



M\* 精定制 — 时尚沟槽系列



25-084



25-085



25-086



25-087



M+ 精定制 — 时尚扣线系列

DOOR AND WALL CABINET · Fashion buckle series

25-088



25-089



25-090



25-091



25-092

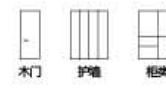

温馨提示：由于天然木材存在纹理差异，本色板仅供选择参考，请以实物为准。 P 38-39

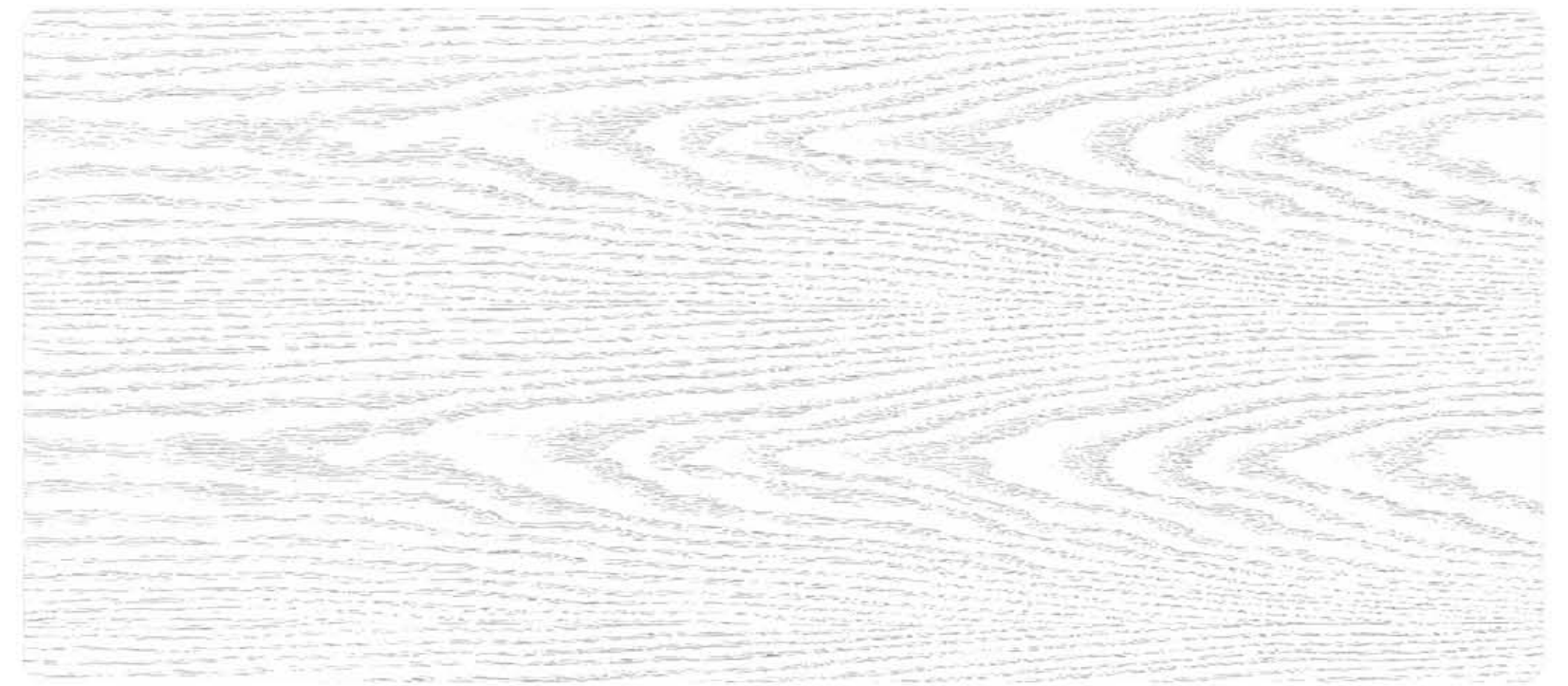

Color Name: | **KF25-43**(红像木皮)

720° 全景体验



门墙柜一体化定制系统 Doors Walls Cabinets



Color Name: | **KF25-44**(红像木皮)

720° 全景体验



门墙柜一体化定制系统 Doors Walls Cabinets



Color Name: | **KF25-45**(红像木皮)

720° 全景体验



门墙柜一体化定制系统 Doors Walls Cabinets

P 40-41 温馨提示：由于天然木材存在纹理差异，本色板仅供选择参考，请以实物为准。

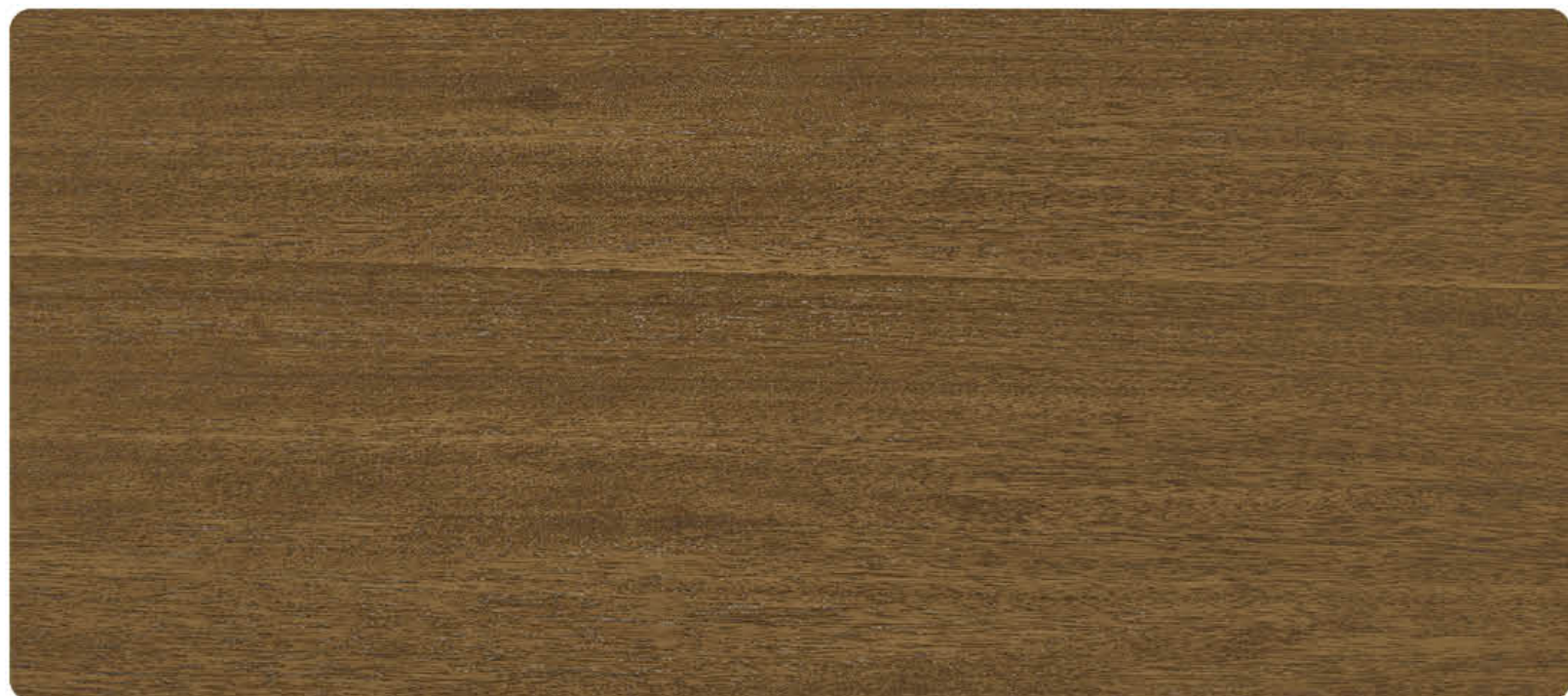

Color Name: **KF25-46**(卡斯楠木皮)

门墙柜一体化定制系统 Doors Walls Cabinets

720° 全景体验



Color Name: **KF25-47**(红橡木皮)

门墙柜一体化定制系统 Doors Walls Cabinets

720° 全景体验

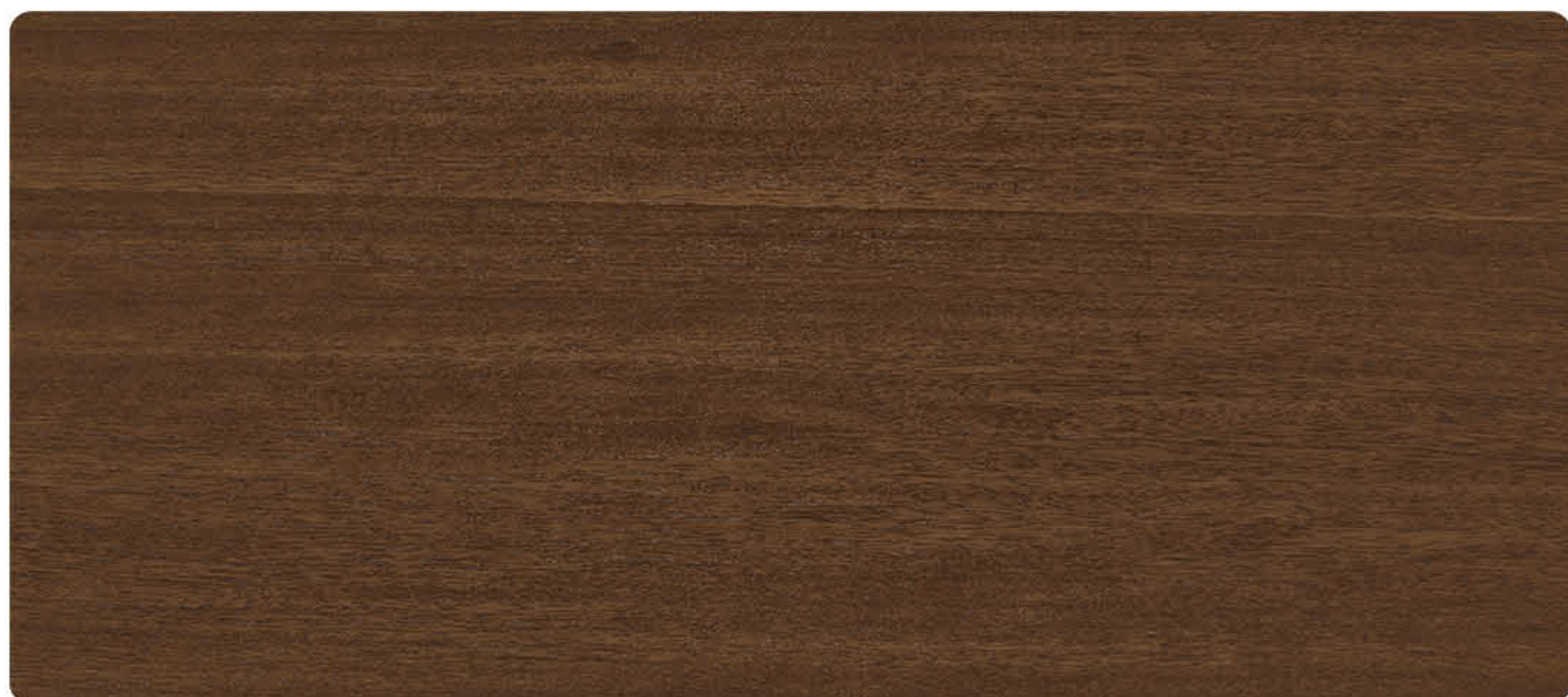

Color Name: **KF25-48**(卡斯楠木皮)

门墙柜一体化定制系统 Doors Walls Cabinets

720° 全景体验



25-093

DOOR AND WALL CABINET · Classic Chinese Series

M+ 精定制 —— 经典中式系列



25-094



25-095



25-096

QUALITY  
品质上乘 独特风格  
UNIQUE SCENERY

不同的视角，呈现不同的交织，  
坚硬的线条包裹着温柔的力量，  
让空间更加灵动洒脱，  
为家居生活带来别样的开合体验。



25-097      25-098      25-099      25-100      25-101



25-102      25-103      25-104      25-105      25-106

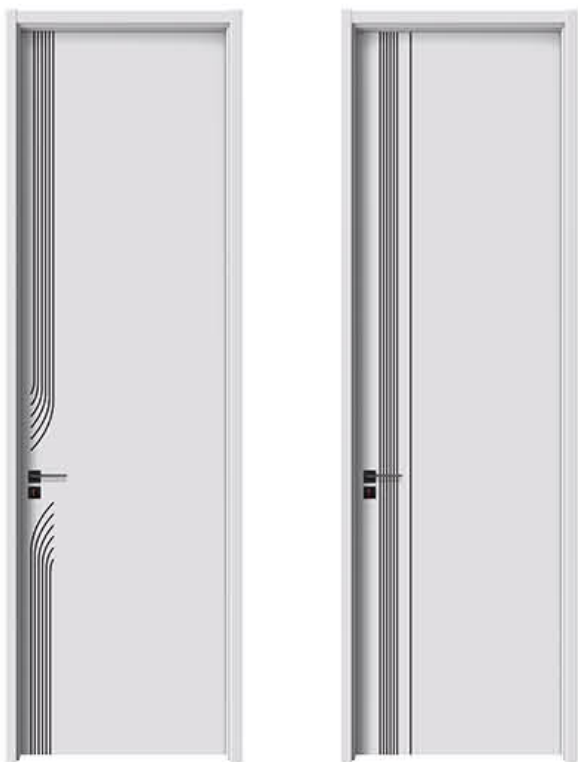

25-107      25-108



25-109



25-110      25-111      25-112      25-113      25-114



25-115      25-116      25-117      25-118



25-119      25-120      25-121      25-122



25-123 25-124 25-125 25-126 25-127



25-128 25-129 25-130 25-131 25-132



25-133 25-134 25-135 25-136 25-137



25-138 25-139 25-140 25-141



25-142 25-143 25-144 25-145



25-146 25-147 25-148 25-149



M\* 精定制 — 时尚沟槽系列

DOOR AND WALL CABINET · Fashion Trench Series



25-150

25-151

25-152

25-153

25-154



25-155

25-156

25-157

25-158

25-159

DOOR AND WALL CABINET · Fashion Trench Series

M\* 精定制 — 时尚沟槽系列



25-160

25-161

25-162

25-163



M<sup>+</sup> 精定制 — 经典中式系列

DOOR AND WALL CABINET · Classic Chinese Series



25-164

25-165

25-166

25-167

25-168



25-169

25-170

25-171

25-172

M<sup>+</sup> 精定制 — 经典中式系列

DOOR AND WALL CABINET · Classic Chinese Series



25-173

25-174

25-175

25-176



25-177

25-178

25-179

25-180

25-181



25-182

25-183

25-184

25-185

25-186

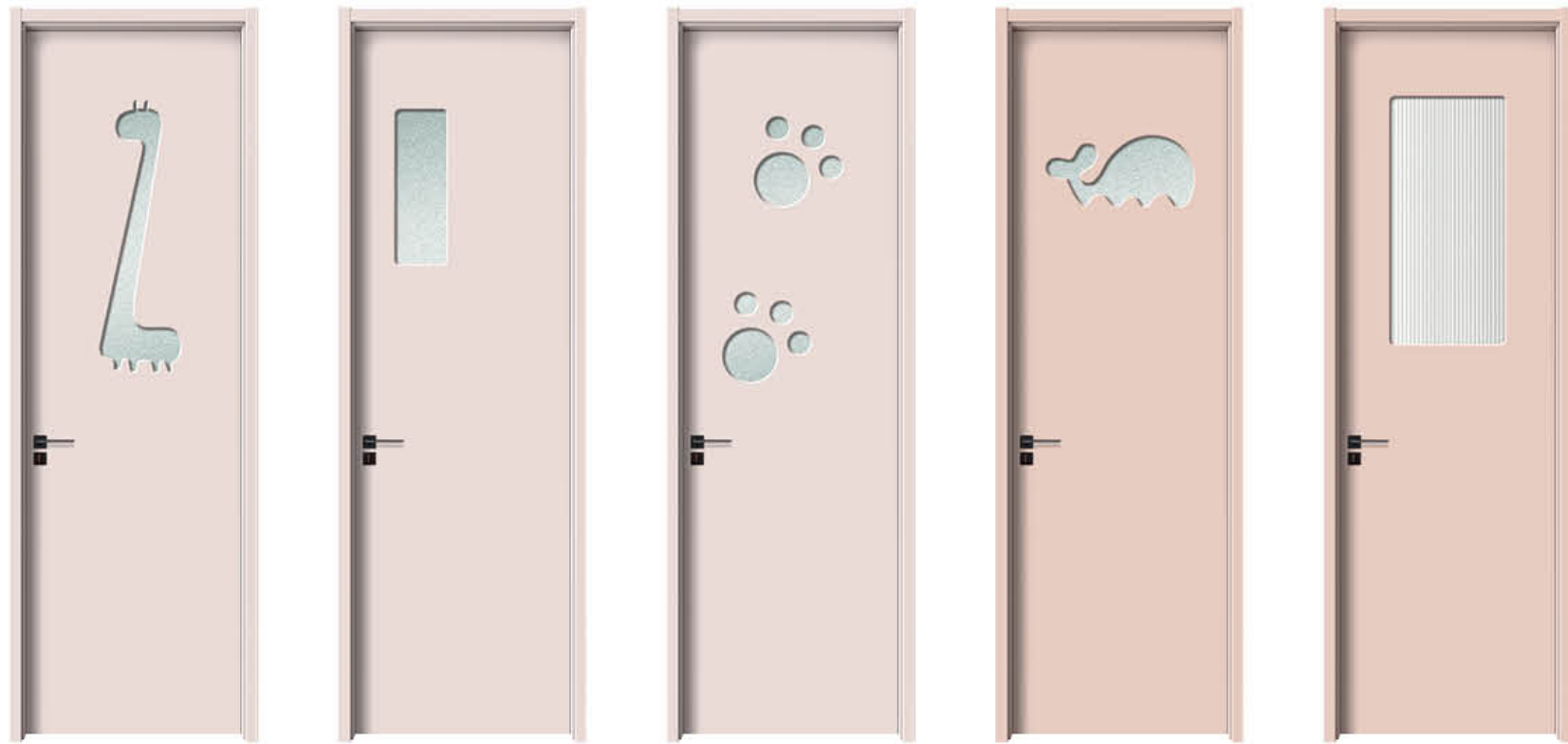

25-187

25-188

25-189

25-190

25-191



25-192

25-193

25-194

25-195

25-196



25-197

25-198

25-199

25-200

25-201



25-202

25-203

25-204

25-205

25-206

25-207



25-208

25-209

25-210

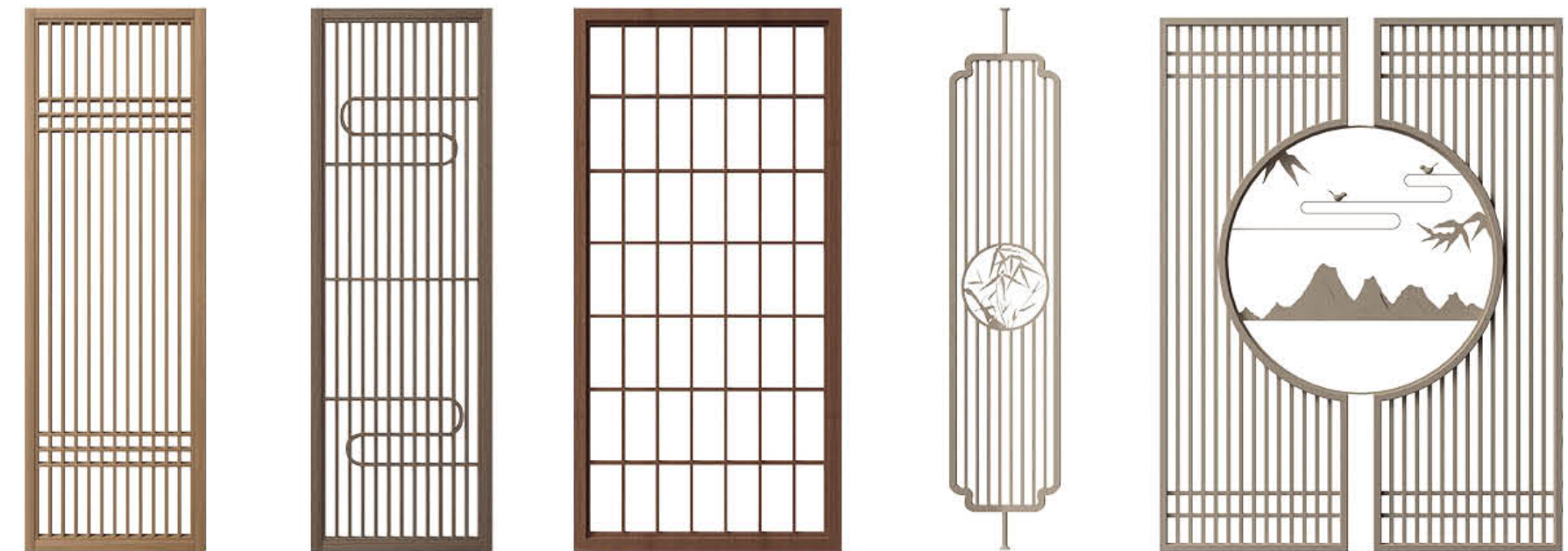

25-211

25-212

25-213

25-214

25-215







可选扣线

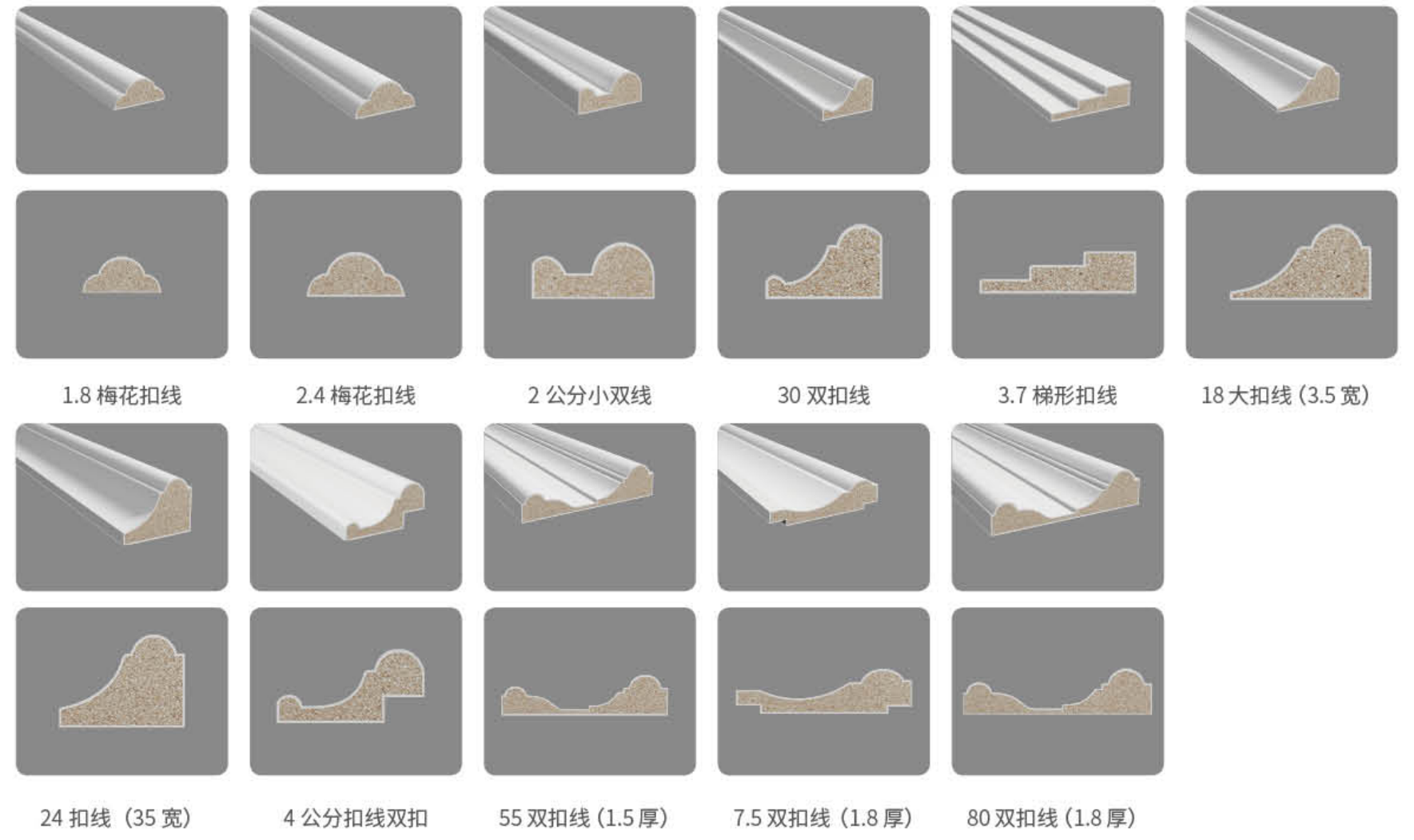

可选线条

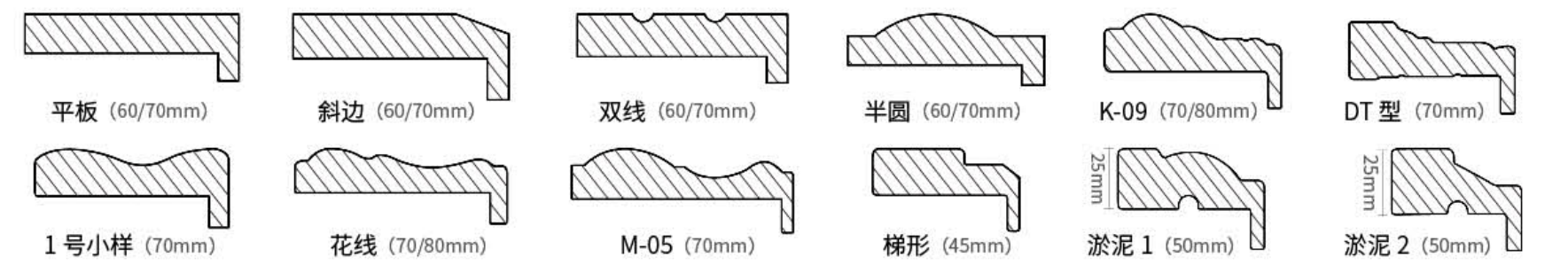

隐形门第几种做法

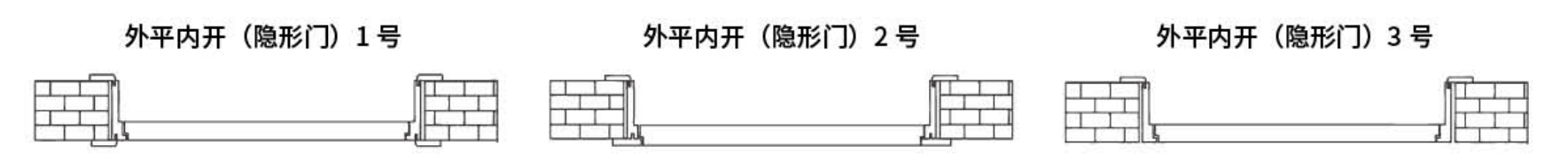

木门尺寸示意图

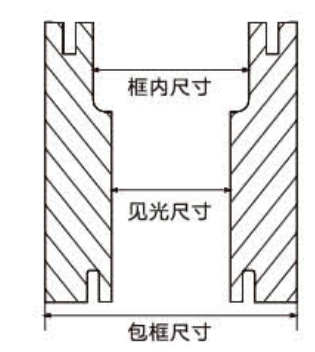

单丁墙示意图

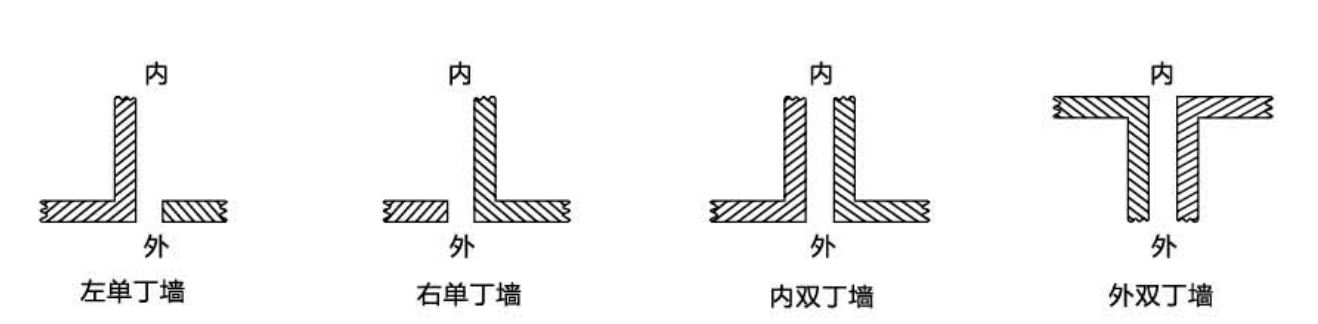

门采口示意图 (人站在室外)

